

1

1.3. ANCHORING SET for foundations

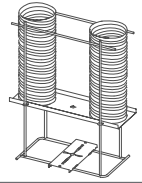

ANCHORING TECHNOLOGY

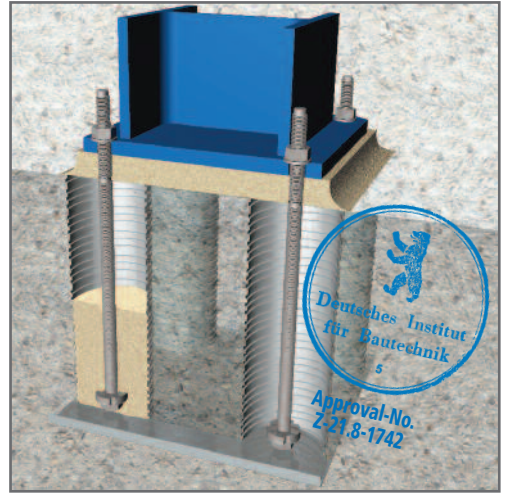

ROBUSTA
GAUKEL

1

ANCHORING SET FOR FOUNDATIONS

GENERAL INFORMATION

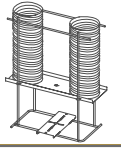

center point

Mounting frame with central template, it defines always the central point in the anchoring group, also with quadruple or sextuple sets.



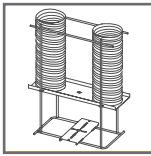

Your benefits at a glance:

- For anchoring all types of steel structures, high-rack systems, machines and concrete components
- With general building authority approval
- Anchoring proved in practice for tie bars with centimetre tolerances in concrete construction work and millimeter tolerances in steel
- Up-to-date force transmission using a shear force interlocking system; no cumbersome traversing anchor bars.
- No costly welding jobs necessary
- Permissible service loads from 15 kN to 400 kN per anchor bar
- Rapid installation in a double or multiple set
- Great level of installation safety due to complete accessory package for right assembly
- All necessary individual components from one source

Approval extended
for seismic impact
in 2020!

With the **ROBUSTA anchoring sets** we offer everyone involved in construction the possibility of a clearly defined and economical anchoring system that is reliable and designed for your practical needs in the critical interface between concrete construction and steel construction. The ROBUSTA anchoring set is the perfect connection between the coarse concrete construction and the very precise constructional engineering or steel construction.

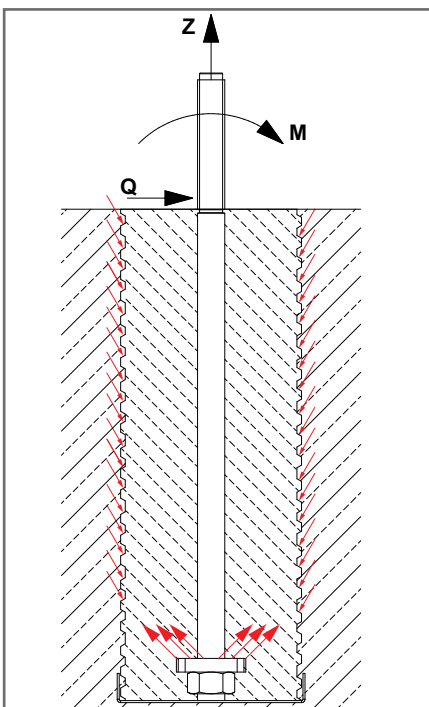

Safe initiation of tension because of tooth construction



As first step, corrugated sleeve tubes are embedded into the concrete base plate or into the foundation, with the included mounting support an exact and quick installation into the reinforcement is guaranteed. Whether single or sextuple set, the whole anchoring group will always be installed and fixed as one unit. After the rough work is complete the tie rods with anchor plates are precisely measured and cast in the tubes.

An installation tolerance up to 10 cm is possible.

Because the entire delivery package is available from ROBUSTA-GAUKEL with the necessary installation aids and templates, identifications and casting grout, there is no more need for improvisation on the construction site. Time consuming template supports built on-site are unnecessary.

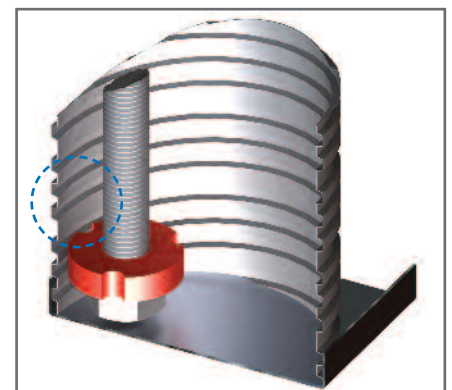

If the anchor plate is adjoining the tube, the grout will entirely enclose the plate due to the indents.



1

ANCHORING SET FOR FOUNDATIONS

PLANNING

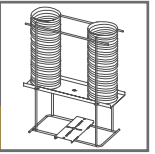

Planning stage

- Anchoring in chapped concrete is permissible
- Safe holding of transverse loads and bending moments
- Written proposal requests available, transparency from the beginning for all involved when determining the construction branches
- Making out of detections without problem and acceptance by an engineer

With the official approval of the construction supervision the direct local initiation of forces is proven. The passing on of the loads to anchor in the construction part has to be proven separately.

More details can be found in the official approval of the construction supervision.

The bearing strength of the anchoring sets is determined by the depth of the anchoring.

In the official approval of the construction supervision the measurements of the single parts are fixed to reach the maximum tension load of the tie rod in the single tube, if there are enough edge- and ax-distances. This value has to be reduced at combined loads with additional transverse forces and when reduced ax- and edge-distances occur.

The measurements and forms of the anchoring sets can be adjusted entirely to the according combination of loads:

With multiple sets with small axis distances it is advantageous to enlarge the depth of anchoring "h_{ef}" in order to improve the failure of concrete break.

For the admission of high transverse loads shear keys have proved useful at the lower end of the base plate of the steel support. We deliver the sets complete with angular integrated boxout on request.

Tie rods 8.8 galvanized

statistic data

Ø tie rod	Limit tension load [kN]	Limit transverse load [kN]	Limit bending moment [Nm]	effective depth of anchoring break of concrete and splits [mm]	char. ax distance (3* h _{ef}) [mm]	min. ax distance [mm]	char. edge distance (1,5* h _{ef}) [mm]	min. edge distance [mm]
	N _{R,d}	V _{R,d}	M _{R,d}	h _{ef}	S _{cr,N} und S _{cr,sp}	s _{min}	c _{cr,N} und c _{cr,sp}	c _{min}
M 10	30.7	18.4	48.0	125	375	100	188	120
M 12	44.7	27.2	84.0	160	480	100	240	120
M 16	84.0	50.4	212.8	245	735	125	368	150
M 20	130.7	78.4	415.2	325	975	155	488	190
M 24	188.0	112.8	718.4	415	1245	190	623	225
M 27	244.7	147.2	1065.6	495	1485	190	743	225
M 30	299.3	179.2	1439.2	565	1695	250	848	300
M 33	370.0	222.4	1980.8	655	1965	250	983	300
M 36	436.0	261.6	2529.6	730	2190	250	1095	300
M 39	520.7	312.0	3303.2	820	2460	250	1230	300
M 42	598.0	358.4	4065.6	900	2700	250	1350	300

Tie rods fine steel

statistic data

Ø Tie rod	Steel grade	Limit tension load [kN]	Limit transverse load [kN]	Limit bending moment [Nm]	Effective depth of anchoring break of concrete and splits [mm]	char. ax distance (3* h _{ef}) [mm]	min. ac distance [mm]	char. edge distance (1,5* h _{ef}) [mm]	min. edge distance [mm]
		N _{R,d}	V _{R,d}	M _{R,d}	h _{ef}	S _{cr,N} und S _{cr,sp}	s _{min}	c _{cr,N} und c _{cr,sp}	c _{min}
M 10	A4-F70	21,9	12,8	26,9	100	300	100	150	120
M 12	A4-F70	31,6	19,2	47,4	130	390	100	195	120
M 16	A4-F70	58,8	35,3	119,9	195	585	125	293	150
M 20	A4-F70	92,0	55,1	234,0	260	780	155	390	190
M 24	A4-F50	61,9	37,0	123,9	200	600	100	300	120
M 27	A4-F50	80,4	48,3	183,6	235	705	125	353	150
M 30	A4-F50	98,3	58,8	247,9	270	810	125	405	150
M 33	A4-F50	121,3	73,1	341,2	310	930	125	465	150
M 36	A4-F50	143,0	85,7	436,1	350	1050	155	525	190
M 39	A4-F50	170,6	102,5	569,3	390	1170	190	585	225
M 42	A4-F50	196,2	117,6	700,8	430	1290	190	645	225



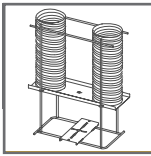

Tie rods 8.8, galvanized geometrical data

Ø tie rod [mm]	Indication	projecting length above tie rod [mm]	Ø tube internal [mm]	Ø tube external [mm]	Ø anchor plate [mm]	total anchoring depth tube with base and cover [mm]
M 10	10-8-1	50	80	87	27	154
M 12	12-8-1	80	80	87	31	191
M 16	16-8-1	100	100	108	41	282
M 20	20-8-1	100	125	133	51	365
M 24	24-8-1	150	150	158	60	463
M 27	27-8-1	150	150	158	70	546
M 30	30-8-1	150	200	208	77	623
M 33	33-8-1	150	200	208	85	715
M 36	36-8-1	200	200	208	92	793
M 39	39-8-1	200	200	208	100	885
M 42	42-8-1	200	200	208	107	970

Tie-rods, fine steel geometrical data

Ø tie rod [mm]	Indication	Projecting length above tie rod [mm]	Ø tube internal [mm]	Ø tube external [mm]	Ø anchor-plate [mm]	total anchoring depth tube with base and cover [mm]
M 10	10-A-1	50	80	87	27	129
M 12	12-A-1	50	80	87	31	161
M 16	16-A-1	100	100	108	41	232
M 20	20-A-1	100	125	133	51	300
M 24	24-A-1	100	80	87	48	239
M 27	27-A-1	100	100	108	55	277
M 30	30-A-1	150	100	108	61	318
M 33	33-A-1	150	100	108	67	360
M 36	36-A-1	150	125	133	73	398
M 39	39-A-1	150	150	158	80	445
M 42	42-A-1	150	150	158	85	488

For the following kinds of failure the characteristic values are fixed:

- For tension load: – failure of steel tie rod
 – break of concrete
 – splitting of the underground
- for transverse load: – with and without lever arm
 – break of concrete on the side load turned off
 – break of concrete on the edge

Hints for the surrounding reinforcement:

Basically it is necessary to design a minimum reinforcement for stability against cracking of the concrete element and for the prove of the stability against collaps. Near the edges it is also necessary to design edge stirrups accordingly as a hold-back reinforcement. It is necessary to plan an according hold-back reinforcement at a load initiation of tension load $NSk \geq 60$ kN.

Hints for the necessary thickness of construction parts:

To guarantee for an entire filling underneath the base plate without air cavities you have to obey the following rules: Underneath the base plate of the anchoring set there must be a **clear cover of 5 cm minimum** at a **wide-meshed reinforcement**. At a **narrow-meshed bottom layer** with big diameters this distance **has to be designed between base plate and the bottom layer**.

The decision whether a wide- or narrow-meshed reinforcement is built in has to be determined by the engineer, depending on the grading of the coarse particles.

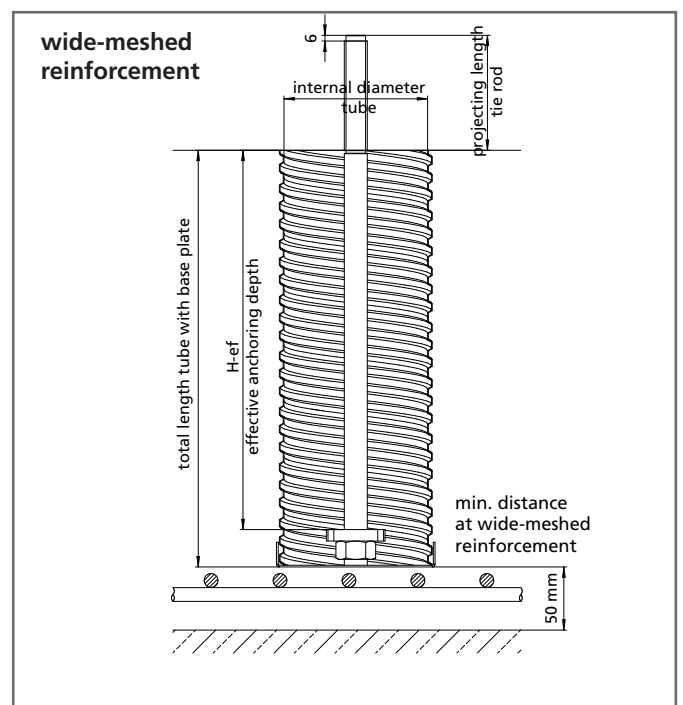
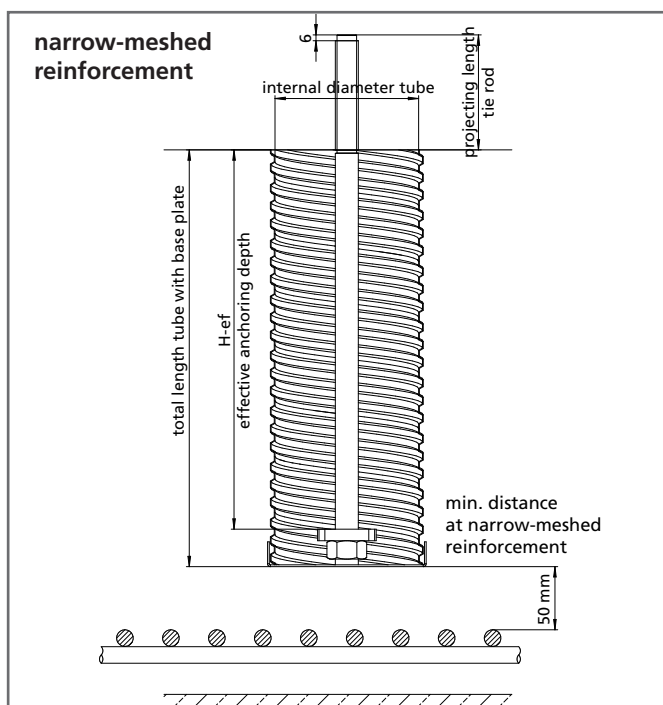

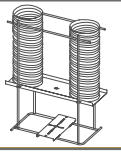

Mounting in construction with concrete

- installing of the ROBUSTA-anchor tubes into concrete foundations and base plates
- easy and exact installation because of also delivered installing helps
- quicker installation because of 2 or 4 tubes on one base plate as a set
- natural stability because of profiling of the tubes

The tubes will be delivered to the site welded onto a base plate single or as a set in batteries of 2, 3, 4 or 6 tubes ready to install. The advantage of an installation of a set is that with one measurement all tubes are automatically placed correctly. This guarantees a precise installation and an enormous saving of time.

A safe and correct positioned installation of the sets when working at the reinforcement, quick and easy because of helpful installation aids:

anchoring set in survey

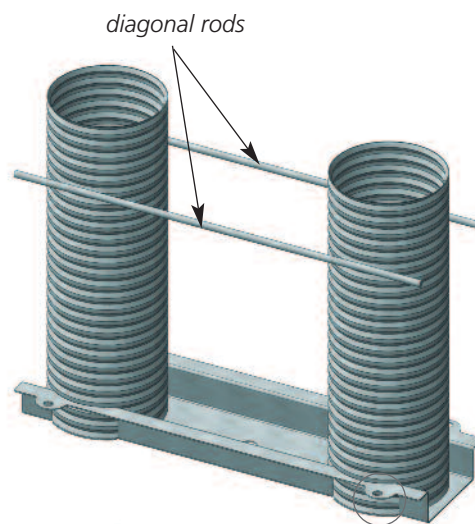

anchoring set, for example double

Fishplates with borehole, these will be slipped onto the 4 vertical rods of the mounting frame.

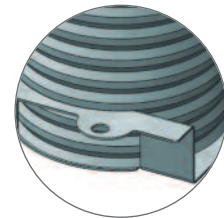

The mounting frames will be delivered separately matching the anchoring sets. This will allow all advantages of a quick and exact installation, also a subsequent correction in the height of installation is possible. Each mounting frame has a central template as a help for centered placing.

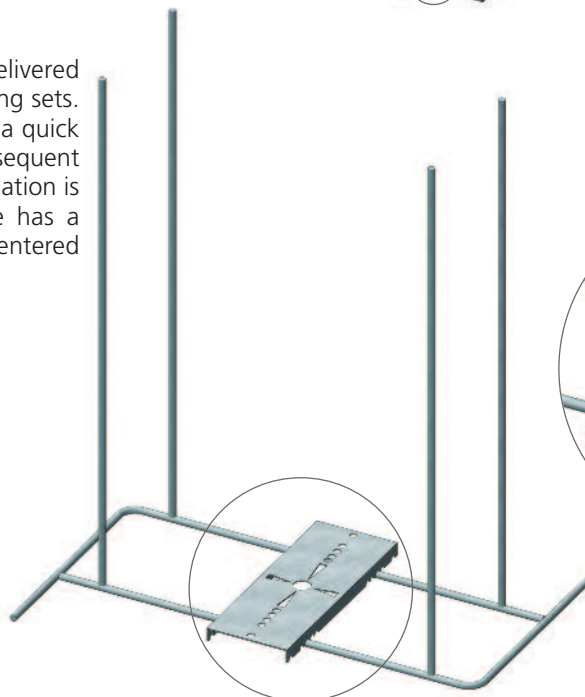

The centered hole shows exactly the axis center point of the whole set.

With the help of the wedge-shaped slits the frame can be adjusted in the correct angle.



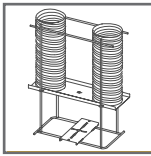

Easy mounting in 3 steps:

1st step: measurement and fixing of the installation frame

The transposition point of the anchoring axes has to be marked on the clean layer. After placing of the lower reinforcement the mounting frames will be placed at the marked axis points and fixed to the reinforcement.

Tipp: marking of the axis center point with the help of a bored tie rod. The central template will be slipped onto the rod and the correct position is guaranteed automatically!



2nd step: installation of the tubes as a set

The anchoring set will be inserted onto the horizontal tie bars of the installation frames and is already fixed and secured to all directions.

The tightening in the correct position of height is done by connecting the reinforcement bars with wire tie.

The second step of installation can be done before or after the laying of the top layer reinforcement.

In both cases it is clear for the user where the mats have to be cut out. An unnecessary removing of big areas will be prevented.

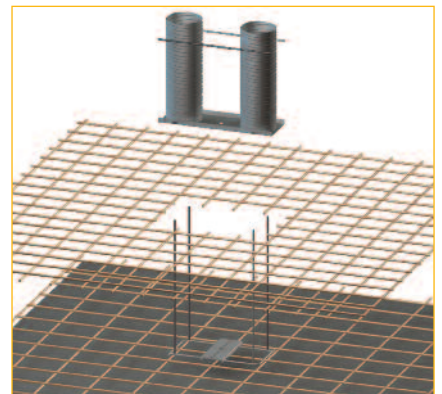

3rd step: before concreting

The upper side of the sets will be connected with the upper reinforcement layer additionally with square rods. Therefore an absolute safety is guaranteed against moving because of a lateral concrete load.

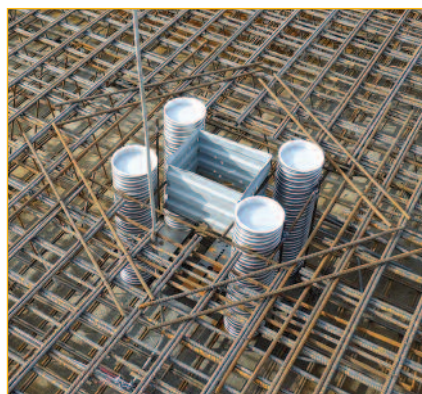
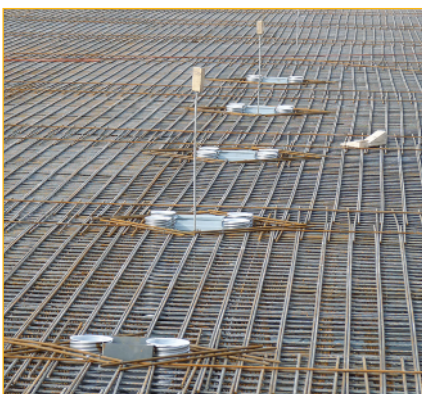

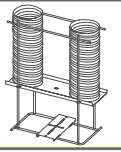

Installation in steel construction:

- Exact and easy measuring of the anchors on the hardened concrete surface
- Easy and exact installation and pouring with also delivered installation templates
- Quick installation with pre-mounted anchor bars with anchor plates
- High installation security because of identical color markings inside the tubes and at the anchor bars
- Great stability because of profiling of the tubes
- Safe pouring because of flowing, not shrinking firm mortar.

After producing the base plate or the foundation the axis of the steel construction can be marked exactly per millimeter directly next to the tubes on the concrete surface.

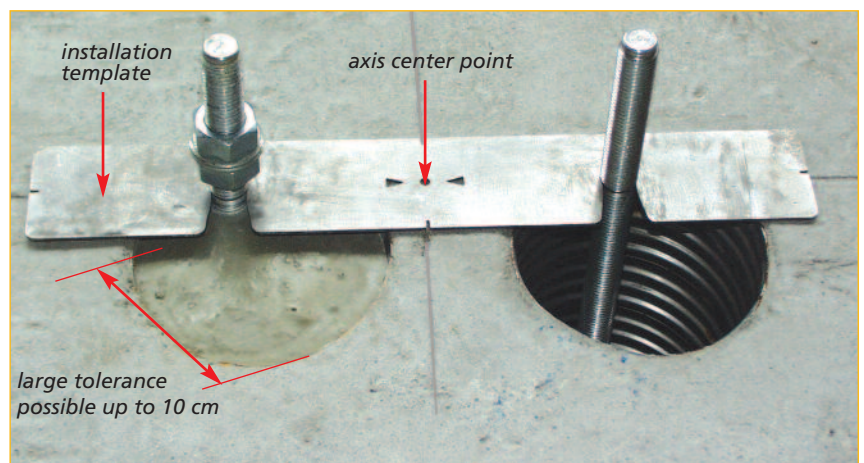

For a correct installation and pouring of the tie rods we can deliver **installation templates** on request. So the tie rods will be installed automatically correct in distance and height. A revolving indent at each tie rod is to control that the necessary length will be kept in the tube and in the pouring grout.

When using the ROBUSTA-template the correct installing depth will result automatically because the tie rod will be hung by the indent into the indentation of the template.

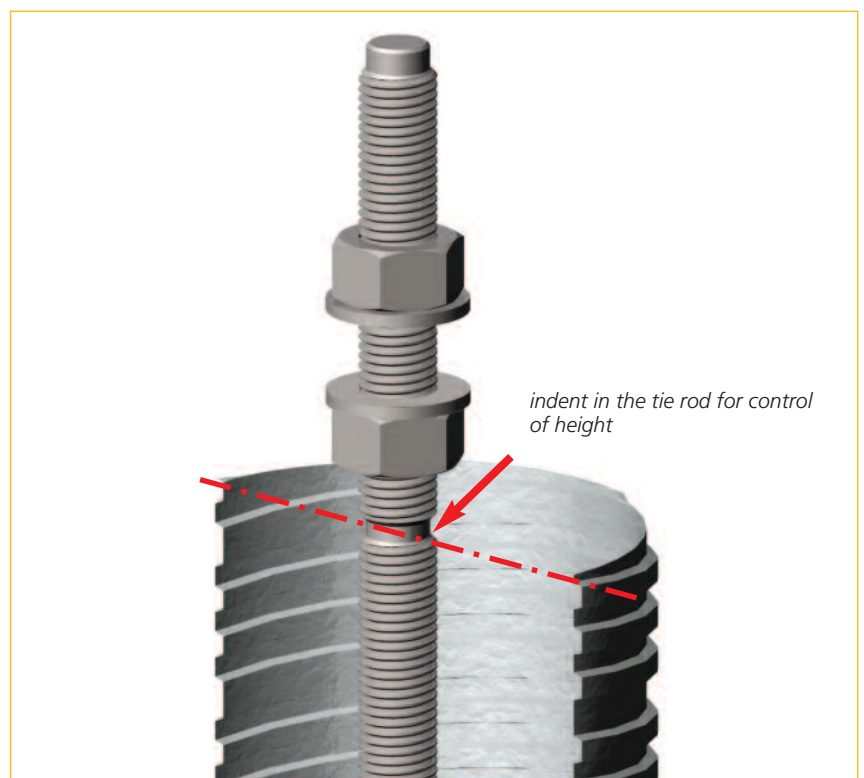

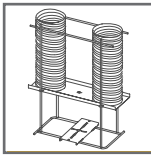

ANCHORING SET FOR FOUNDATIONS

1

STAHLBAU

The tubes will be filled with the ROBUSTA grout for anchoring, which is optimized for size of grain and consistence. After hardening of the grout the construction to connect can be anchored with a defined pretension.

Please note the processing hints printed on the bag.

The marking of the anchor bars is still visible on the upper end after installing and allows the inspector a subsequent controlling of the anchoring at any time.



Pouring the grout into the tubes



Exact mounting with fitting installation template

Tie rods 8.8, galvanized

Max. torque when fixing the construction part

Ø tie rod [mm]	max. T _{inst} [Nm]
M 10	50
M 12	80
M 16	180
M 20	250
M 24	430
M 27	620
M 30	840
M 33	1100
M 36	1500
M 39	1900
M 42	2300



Tie rods, fine steel

Max. torque when fixing the construction part

Ø tie rod [mm]	max. T _{inst} [Nm]
M 10	50
M 12	80
M 16	180
M 20	250
M 24	210
M 27	290
M 30	390
M 33	520
M 36	680
M 39	860
M 42	1100



1

ANCHORING SET FOR FOUNDATIONS

DELIVERY PROGRAMME A): SHELL / CONCRETE CONSTRUCTION

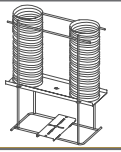

Anchoring set, complete with closing cover above

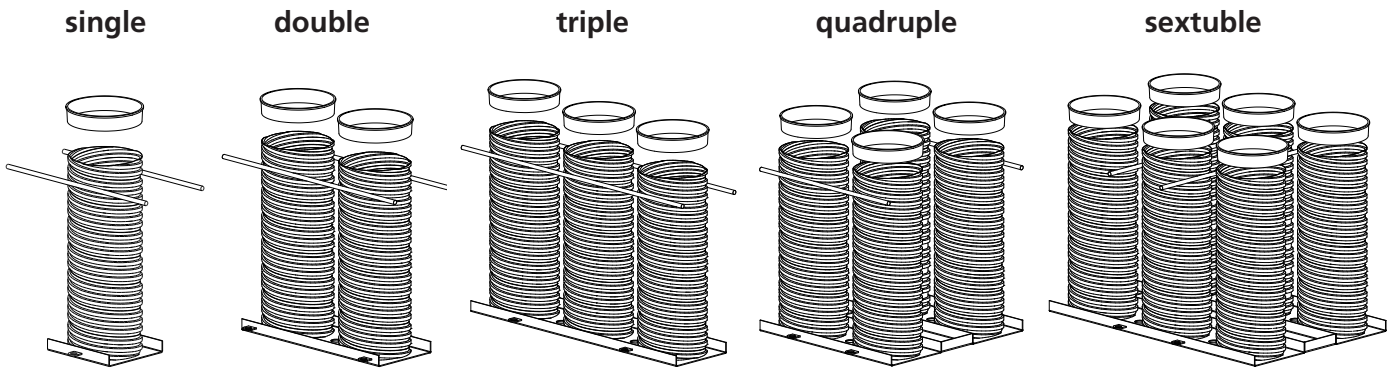

Item No. 15



material*

Number of tubes/set

Diameter of tie rods

*8 for tie rods 8.8, 2 für tie rods made of fine steel

Example for order: 158424

Quadruple anchoring set for the installation with height adjustable mounting frame

The measurements of the anchor tube are also included in this statements at Ø 150 x 459 mm for tie rods 8.8 galvanized, size M 24 (see the table on page 5)

Example for order: 152224

Double anchoring set for the installation with height adjustable mounting frame

The measurements of the anchor tube are also included in this statements at Ø 80 x 235 mm for tie rods A4 fine steel, size M 24 (see the table on page 5)

Mounting frame

Measurements according to order referring to the size of the anchoring set and thickness of base plate with central template sheet.

Item No. 150100

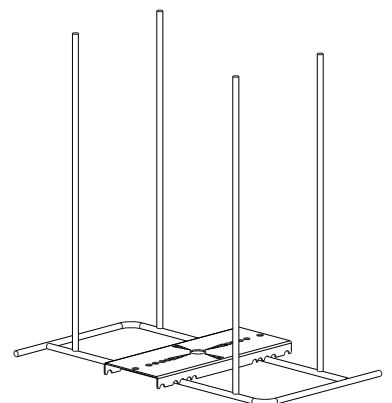

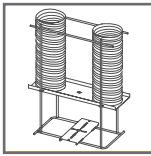

ANCHORING SET FOR FOUNDATIONS

1

DELIVERY PROGRAMME B): FOR STEEL CONSTRUCTION

anchor bars and pouring grout

Item No. 16



Material*

Number of tubes/set

Diameter of tie rods

*8 for tie rods 8.8, 2 for tie rods made of fine steel

Example for order: 168424

Includes **4 sets of tie rods** 8.8 galvanized, size M24, complete with mounted anchor plate, per set 2 nuts and 2 supporting disks, enclosed loose (see the table on page 4).

Example for order: 162224

2 sets of tie rods A4, fine steel, size M24, complete with mounted anchor plate, per set 2 nuts and 2 supporting disks, enclosed loose (see the table on page 4)

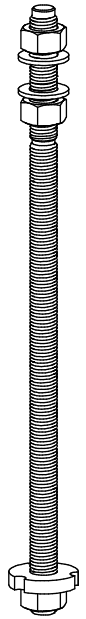

Pouring grout 4-50-90

Single sacks each 25 kg for subsequent orders

Item No. 165090



Template sheet

Measurements according to order referring to the size of the anchoring set and of the anchor spaces.

Item No. 160020

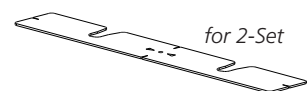

for 2-Set

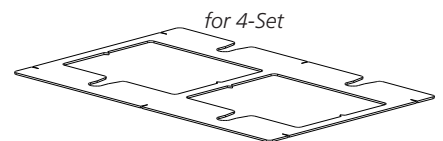

for 4-Set



ROBUSTA-GAUKEL GMBH & CO. KG

Headquarter:

Brunnenstraße 36
D-71263 Weil der Stadt-Hausen
Phone +49 70 33 537 10
Fax +49 70 33 537 131
Internet www.robusta-gaukel.com
e-Mail info@robusta-gaukel.com

Berlin office:

Rohdestraße 19
D-12099 Berlin (Tempelhof)
Phone +49 30 75 70 70 00
Fax +49 30 75 70 70 07
Internet www.robusta-gaukel.com
e-Mail nl-berlin@robusta-gaukel.com